

Versa locks with a keypad interface are operated by a 4-7 digit User Code or by an ADA compliant User Key. Manager Keys provide management access and external power. Programming is accomplished via a Programming Key unique to the lock system. For Advanced Models of Versa, an optional mobile application tool is available to simplify lock system management and provide audit trail.

## Lock Orientation

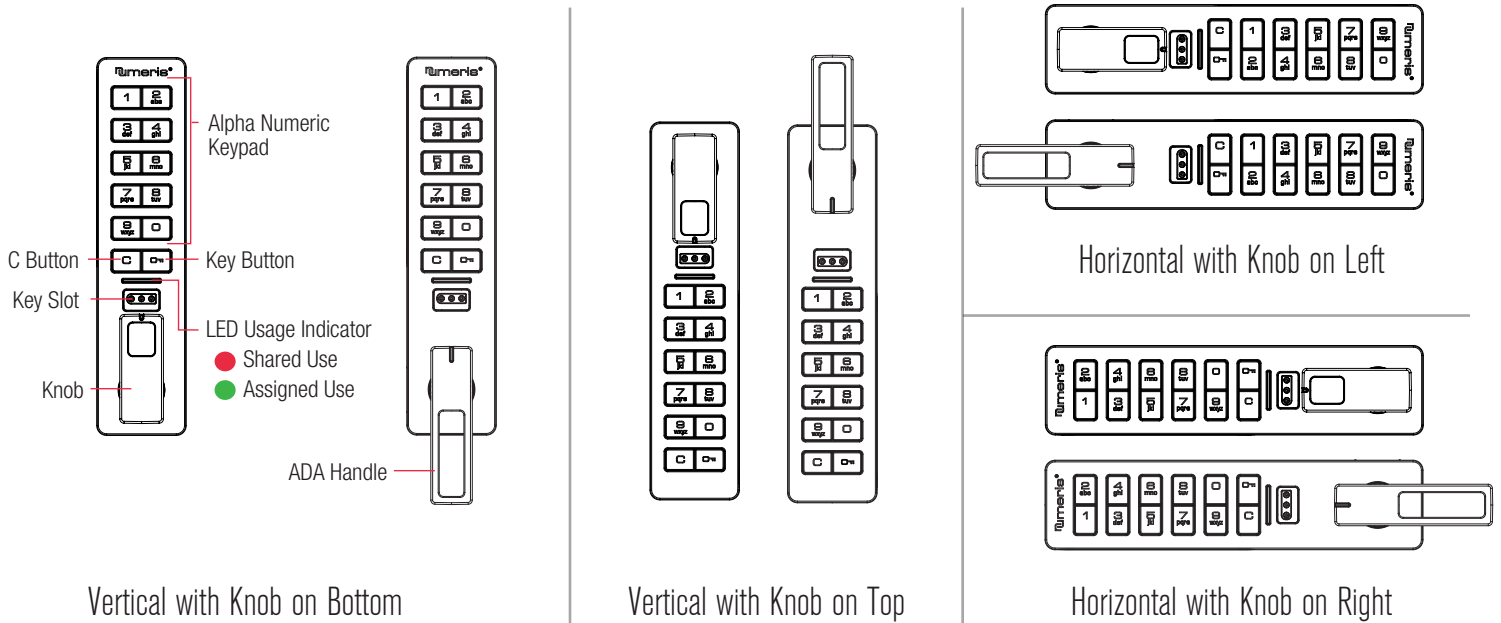

## Keys



	User Key	Manager Key <sup>1</sup>	Programming Key <sup>2</sup>
Operates the lock	•	•	•
Overrides user access		•	•
Allows management inspection		•	•
Provides external power		•	•
Programs Manager Keys to the lock			•
Assigns user credentials <sup>3</sup> (in assigned use functionality)		•	
Sets lock functionality			•

<sup>1</sup> Up to 6 Manager Keys may be programmed to each lock.  
<sup>2</sup> 1 Programming Key allowed per lock system.  
<sup>3</sup> Up to 20 user credentials may be assigned to each lock.

## Key Insertion

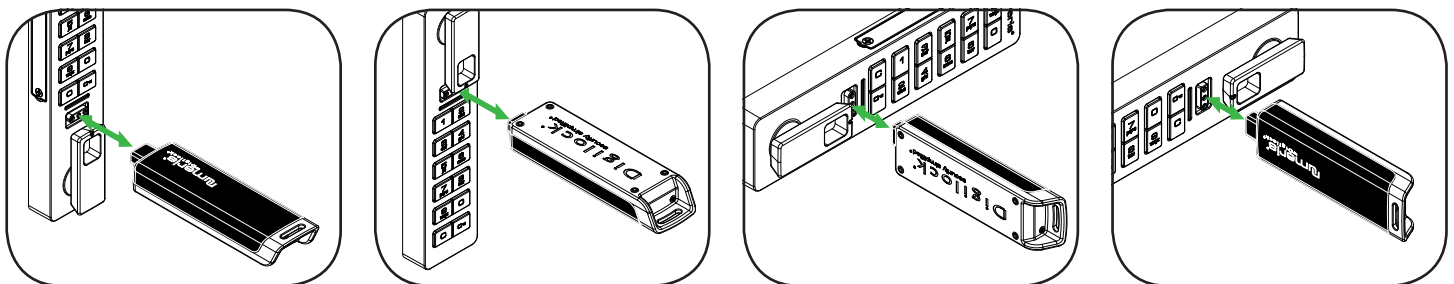

Numeris logo must face towards the keypad.

## Setup

Locks are shipped with factory default settings (only operates by pressing **[C]** **[0π]**). Each lock must be set up to operate with a Programming Key and Manager Keys.

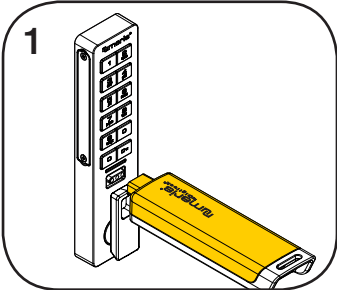

1  
Insert the Programming Key.  
A two-tone beep will be heard and the LED will flash.

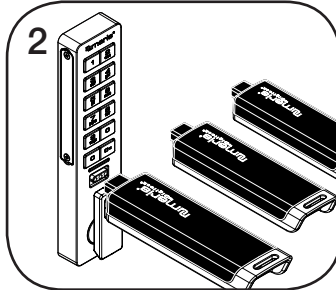

2  
While the LED is flashing, insert one Manager Key at a time.  
A beep will be heard for each Manager Key programmed.

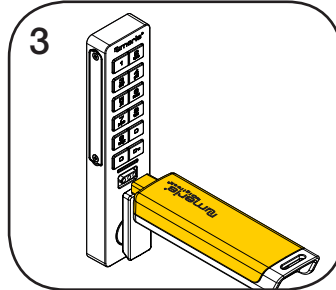

3  
Insert the Programming Key.  
A two-tone beep will be heard and the LED will turn off.

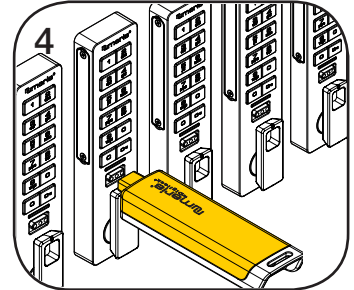

4  
Repeat above steps for each lock or follow instructions to Express Register Manager Keys to setup all locks.

## Programming Instructions

### Express Register Manager Keys

The Programming Key can quickly program multiple locks to operate with the same Manager Keys.

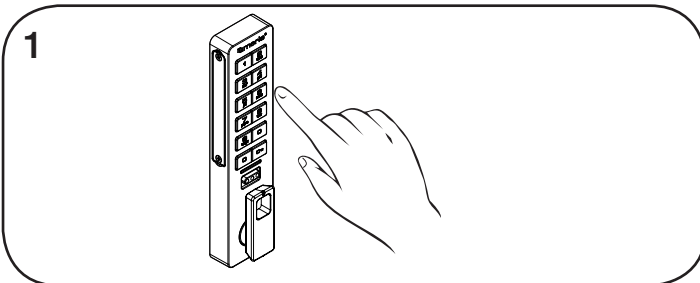

1  
Go to a lock already programmed to operate with the Manager Keys.

Press **[C]** **[0π]** **[6]** **[1]** **[0π]**.

The LED will flash.

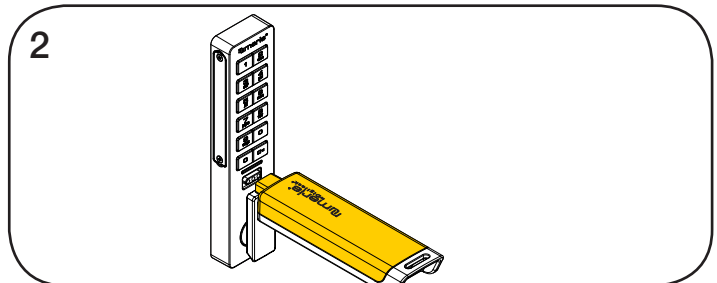

2  
While the LED is flashing, insert the Programming Key.  
A two-tone beep will be heard and the LED will turn off.

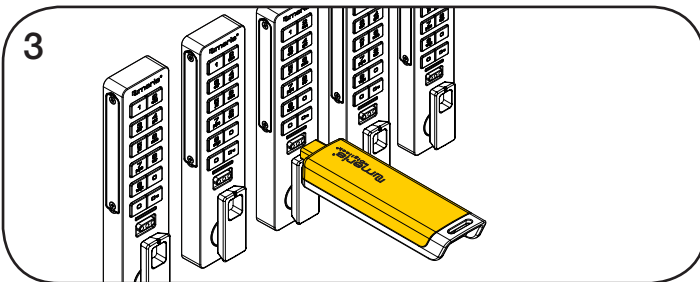

3  
Insert the Programming Key to program each lock to operate with the same Manager Keys.

Two sets of two-tone beeps will be heard and the LED will flash twice to indicate successful programming.

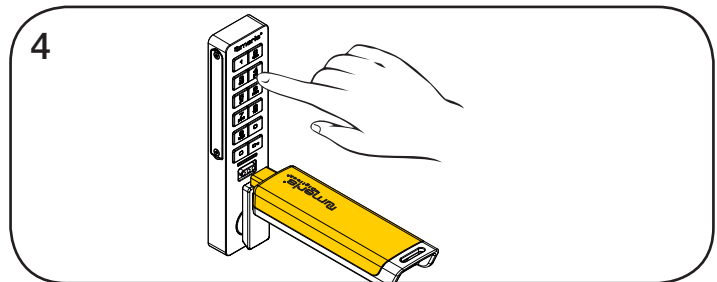

4  
End Express Registration mode.\*

Go to any programmed lock.

Press **[C]** **[0π]** then insert the Programming Key.

\*The Programming Key will continue to function in Express Registration mode until it is used to operate a lock.

## Programming Instructions

### Add Manager Keys

Manager Keys can be programmed to the locks at any time.

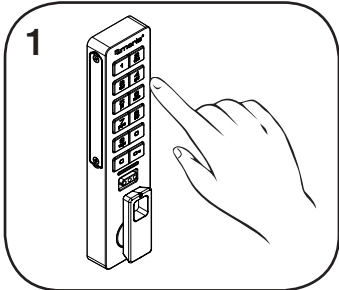

Go to a lock requiring additional Manager Keys.

Press **[C] [0π] [5] [5] [0π]**.

The LED will flash.

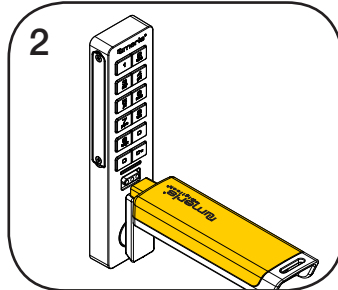

While the LED is flashing, insert the Programming Key.

A two-tone beep will be heard.

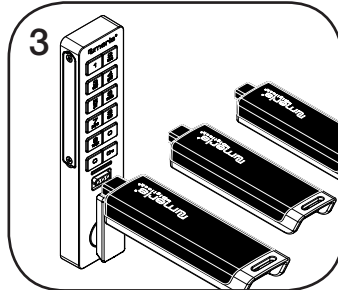

While the LED is flashing, insert each additional Manager Key one at a time.

A beep will be heard for each Manager Key programmed.

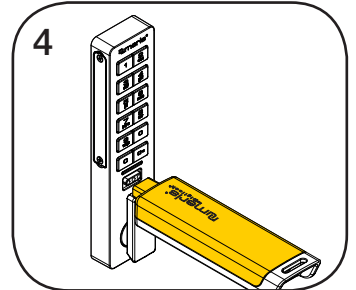

Insert the Programming Key.

A two-tone beep will be heard and the LED will turn off.

Repeat above steps for each lock or follow instructions to [Express Register Manager Keys](#) to quickly program multiple locks to operate with the same Manager Keys.

### Replace Keys

The locks must be reprogrammed to prevent the lost/stolen keys from operating a lock.

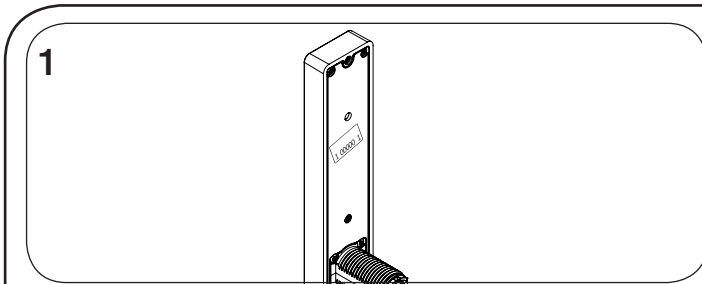

#### To replace the Programming Key:

Note the order or serial number (found on the lock's rear).

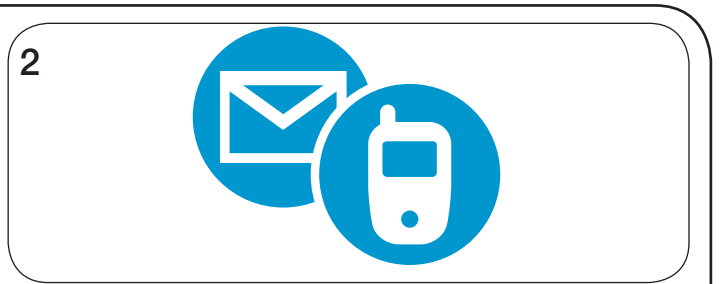

Contact Digilock Support to purchase a replacement Programming Key.

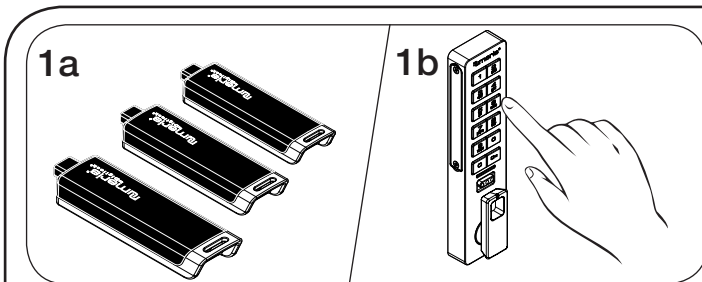

#### To replace the Manager Keys:

Collect all remaining and replacement Manager Keys.

Go to any lock operated by the lost/stolen Manager Keys.

Press **[C] [0π] [5] [5] [0π]**.

The LED will flash.

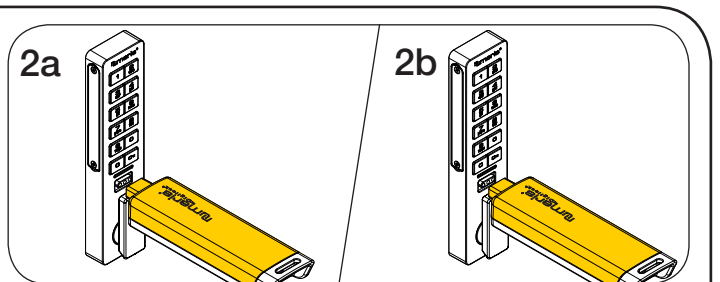

While the LED is flashing, insert the Programming Key.

A two-tone beep will be heard.

Insert the Programming Key again.

Three sets of two-tone beeps will be heard and the LED will turn off. All previously programmed Manager Keys will be erased.

Follow instructions to [Add Manager Keys](#) to program the remaining and replacement Manager Keys to the locks.

## Programming Instructions

### Set Lock Functionality

Each lock can be set for either shared or assigned use functionality. Press **[C]** to check functionality. If in shared use, LED is red. If in assigned use, LED is green.

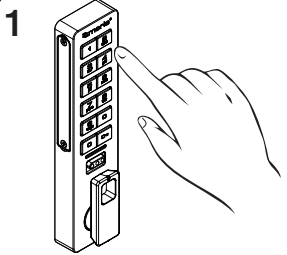
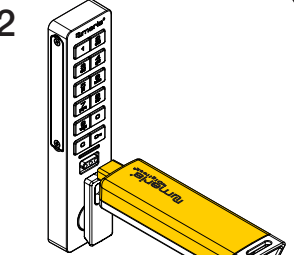
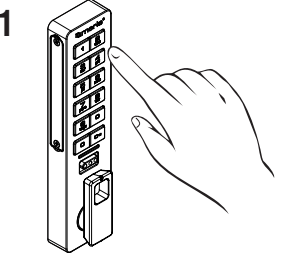
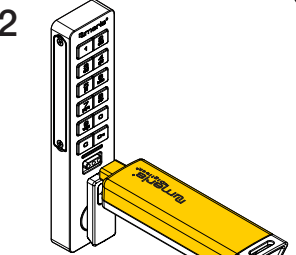
 <p><b>1</b></p>	 <p><b>2</b></p>	 <p><b>1</b></p>	 <p><b>2</b></p>
<p><b>To set for assigned use:</b> Press <b>[C]</b> <b>[0]</b> <b>[6]</b> <b>[5]</b> <b>[0]</b>. The red LED will turn on.</p>		<p><b>To set for shared use:</b> Press <b>[C]</b> <b>[0]</b> <b>[5]</b> <b>[6]</b> <b>[0]</b>. The green LED will turn on.</p>	
<p>Insert the Programming Key. A two-tone beep will be heard and the green LED will flash once.</p>		<p>Insert the Programming Key. A two-tone beep will be heard and the red LED will flash once.</p>	

## Programming Instructions - In Shared Use Functionality

### Auto Unlock

When in shared use functionality, each lock can be programmed to auto unlock after a set number of hours. The default setting is OFF (does not auto unlock).

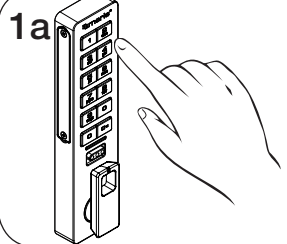
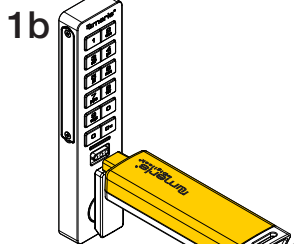
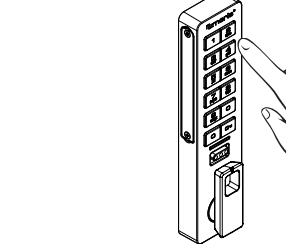
 <p><b>1a</b></p>	 <p><b>1b</b></p>	 <p><b>2</b></p>
<p><b>To turn on Auto Unlock:</b> Press <b>[C]</b> <b>[0]</b> <b>[9]</b> <b>[5]</b> <b>[0]</b>. The LED will flash. While the LED is flashing, insert the Programming Key. A two-tone beep will be heard and the LED will turn on.</p>		<p>While the LED is on, enter the number of hours from <b>[1]</b> - <b>[9]</b> <b>[9]</b> then press <b>[0]</b>. Two sets of two-tone beeps will be heard and the LED will turn off. For example: Press <b>[8]</b> <b>[0]</b> to set the lock to auto unlock 8 hours after locking.</p>

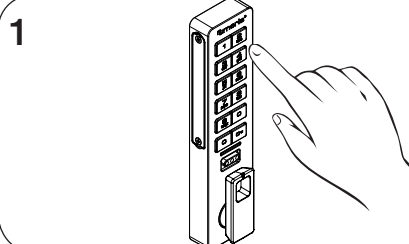
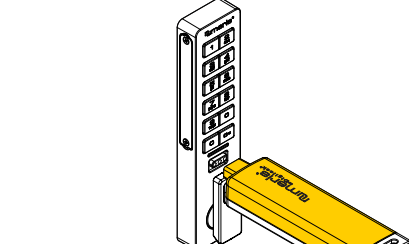
 <p><b>1</b></p>	 <p><b>2</b></p>
<p><b>To turn off Auto Unlock:</b> Press <b>[C]</b> <b>[0]</b> <b>[9]</b> <b>[4]</b> <b>[0]</b>. The LED will flash.</p>	
<p>While the LED is flashing, insert the Programming Key. A two-tone beep will be heard and the LED will turn off.</p>	

## Programming Instructions - In Shared Use Functionality

### Assign User Credentials (for assigned use functionality only)

Make sure that the lock is set for assigned use functionality (a green LED will flash when [C] is pressed). Up to 20 user credentials (User Codes and/or User Keys) may be assigned to each lock.

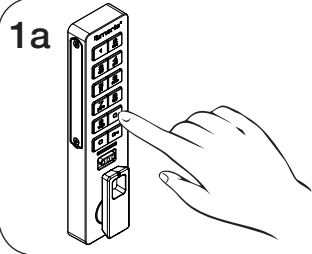

**1a**

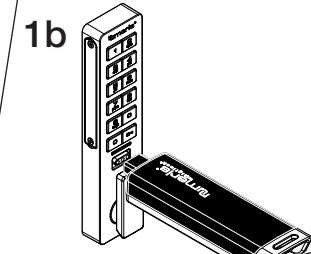

**1b**

**Assign User Codes:**  
Press [C] [0π] [5] [5] [0π].  
The LED will flash.  
While the LED is flashing, insert a valid Manager Key.  
A two-tone beep will be heard and the LED will turn on.

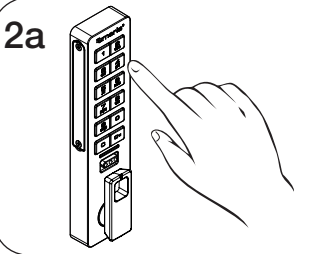

**2a**

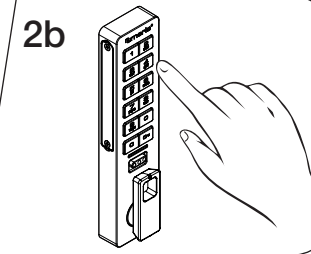

**2b**

While the LED is on, press [C] [new 4-7 digit code] [0π].  
A two-tone beep will be heard.  
Press [C] [the same 4-7 digit code] [0π].  
Two sets of two-tone beeps will be heard and the LED will turn off.

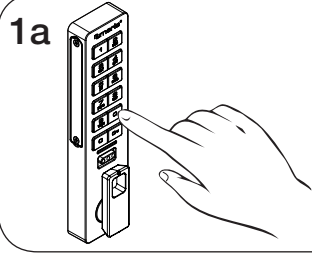

**1a**

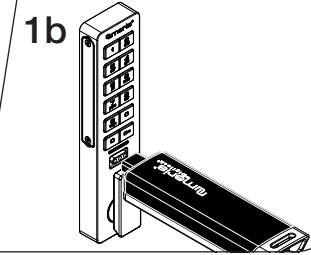

**1b**

**Assign User Keys:**  
Press [C] [0π] [5] [5] [0π].  
The LED will flash.  
While the LED is flashing, insert a valid Manager Key.  
A two-tone beep will be heard and the LED will turn on.

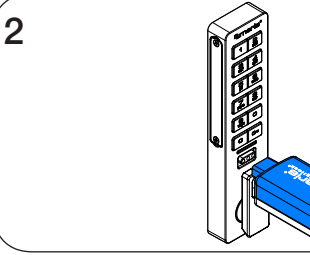

**2**

While the LED is on, insert a User Key.  
Two sets of two-tone beeps will be heard and the LED will turn off.

### Express Register User Credentials and Manager Keys (for assigned use functionality only)

Make sure the lock is set for assigned use functionality (a green LED will flash when [C] is pressed). The Programming Key can quickly program multiple locks to operate with the same user credentials and Manager Keys.

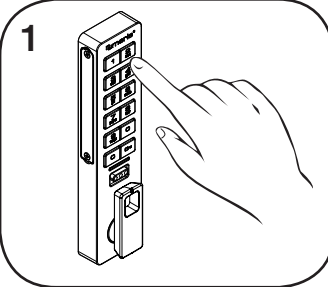

**1**

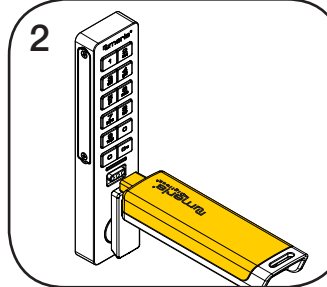

**2**

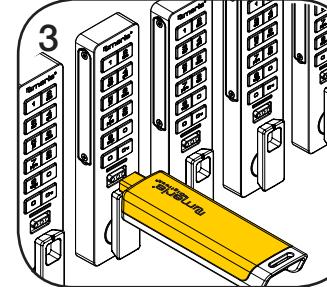

**3**

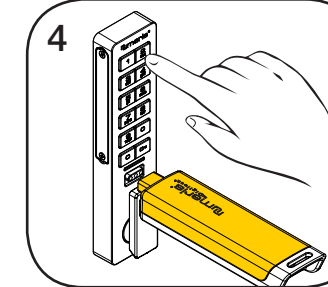

**4**

Go to a lock already programmed to operate with the user credentials and Manager Keys.  
Press [C] [0π] [6] [6] [0π].  
The LED will flash.

While the LED is flashing, insert the Programming Key.  
A two-tone beep will be heard and the LED will turn off.

Insert the Programming Key to program each lock to operate with the same user credentials and Manager Keys.  
Two sets of two-tone beeps will be heard and the LED will flash twice to indicate successful programming.

End Express Registration mode.\*  
Go to any programmed lock.  
Press [C] [0π] then insert the Programming Key.

\*The Programming Key will continue to function in Express Registration mode until it is used to operate a lock.

## Programming Instructions - In Shared Use Functionality

### Remove User Credentials (for assigned use functionality only)

Make sure the lock is in assigned use functionality (a green LED will flash when **[C]** is pressed). The locks must be reprogrammed to remove user credentials from operating a lock.

1

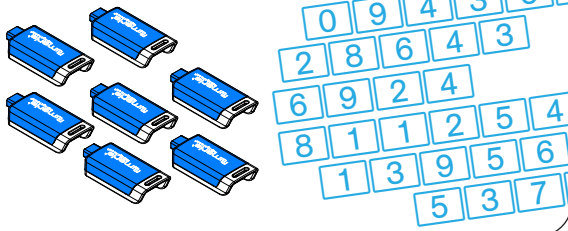

Collect all remaining and replacement user credentials (User Codes and User Keys).

2a

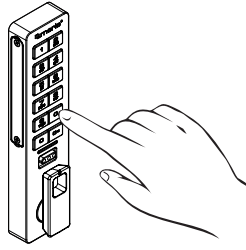

Press **[C] [0π]** **[5] [5]** **[0π]**.

The LED will flash.

While the LED is flashing, insert a valid Manager Key.

A two-tone beep will be heard.

2b

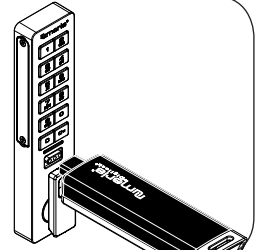

3

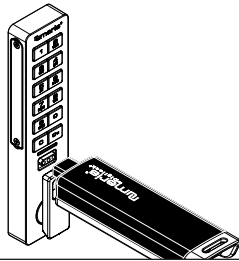

Insert the Manager Key again.

Three sets of two-tone beeps will be heard and the LED will turn off. All previously assigned user credentials will be removed.

4

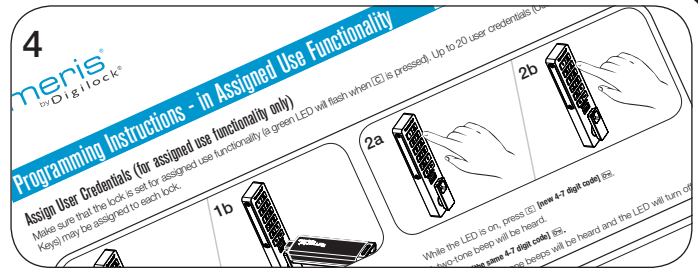

Follow Assign User Credentials instructions to assign the remaining and replacement user credentials to the locks.

### Replace an Assigned User Credential

1

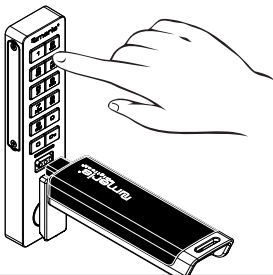

#### Replace an Assigned User Code with a New User Code:

Press **[C] [0π]** then insert a valid Manager Key.

A two-tone beep will be heard and the LED will turn on.

2

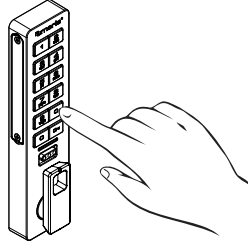

While the LED is on, press **[C] [assigned user code] [0π]**.

A two-tone beep will be heard.

3

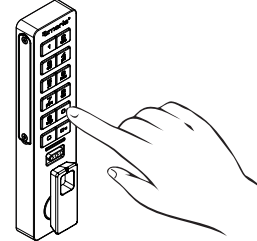

While the LED is on, press **[C] [new 4-7 digit user code] [0π]**  
**[C] [the same 4-7 digit user code] [0π]**.

Two sets of two-tone beeps will be heard and the LED will turn off.

## Programming Instructions - In Assigned Use Functionality

### Replace an Assigned User Credential

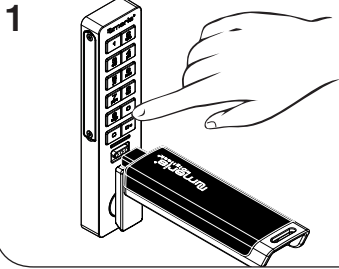

#### 1 Replace an Assigned User Code with a New User Key:

Press **[C] [0π]** then insert a valid Manager Key.  
A two-tone beep will be heard and the LED will turn on.

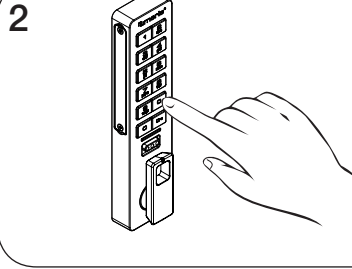

While the LED is on,  
press **[C] [assigned user code] [0π]**.  
A two-tone beep will be heard.

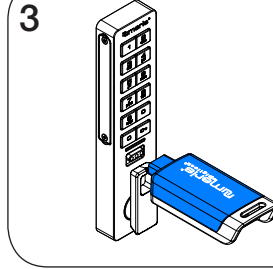

While the LED is on, insert a new User Key.  
Two sets of two-tone beeps will be heard and the LED will turn off.

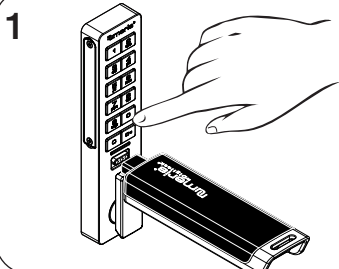

#### 1 Replace an Assigned User Key with a New User Key:

Press **[C] [0π]** then insert a valid Manager Key.  
A two-tone beep will be heard and the LED will turn on.

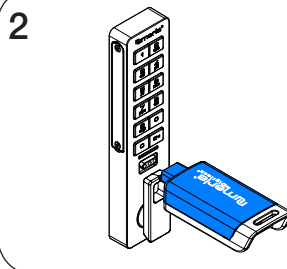

While the LED is on, insert the assigned user Key.  
A two-tone beep will be heard.

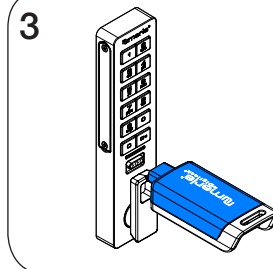

While the LED is on, insert a new User Key.  
Two sets of two-tone beeps will be heard and the LED will turn off.

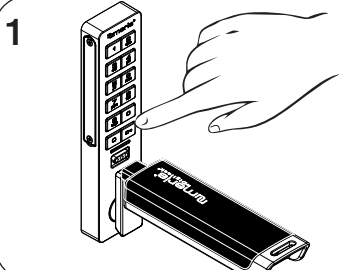

#### 1 Replace an Assigned User Key with a New User Code:

Press **[C] [0π]** then insert a valid Manager Key.  
A two-tone beep will be heard and the LED will turn on.

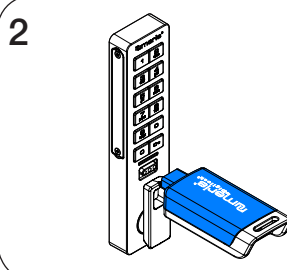

While the LED is on, insert the assigned User Key.  
A two-tone beep will be heard.

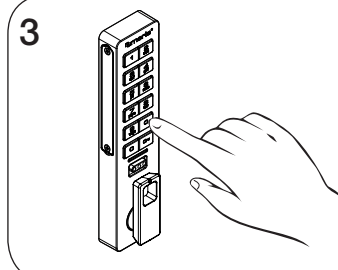

While the LED is on,  
Press **[C] [new 4-7 digit user code] [0π]**  
**[C] [the same 4-7 digit user code] [0π]**.  
Two sets of two-tone beeps will be heard and the LED will turn off.

## Operating Instructions - In Shared Use Functionality

In shared use functionality, the user enters any 4-7 digit User Code or inserts any User Key to lock and the same User Code or User Key to unlock. Once unlocked, the lock is available for a different user.

**1a**

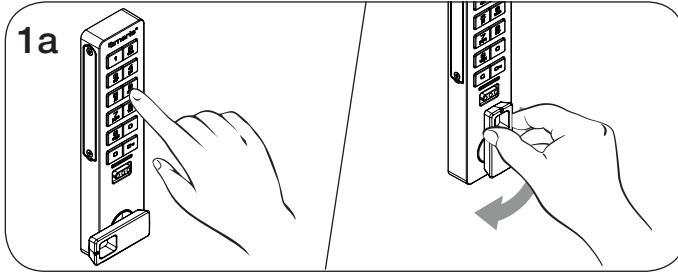

**Operate with a User Code**

To lock: Close the door. Press **[C]** [any 4-7 digit code] **[M]** then turn the knob to the locked position.

**1b**

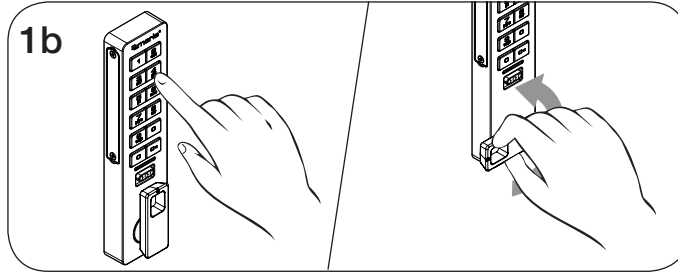

To unlock: Press **[C]** [the same 4-7 digit code] **[M]** then turn the knob to the unlocked position.

Open the door.\*

**1a**

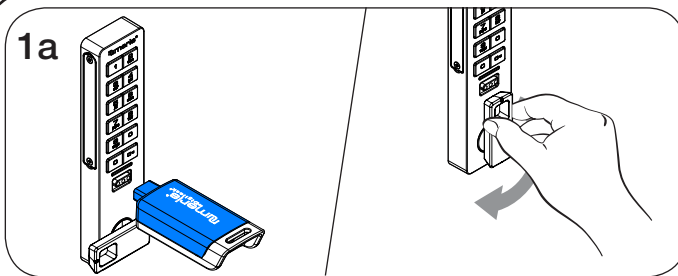

**Operate with a User Key**

To lock: Close the door. Insert any User Key then turn the knob to the locked position.

**1b**

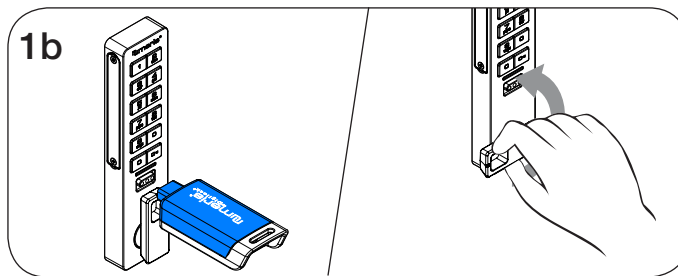

To unlock: Insert the same User Key then turn the knob to the unlocked position.

Open the door.

**1a**

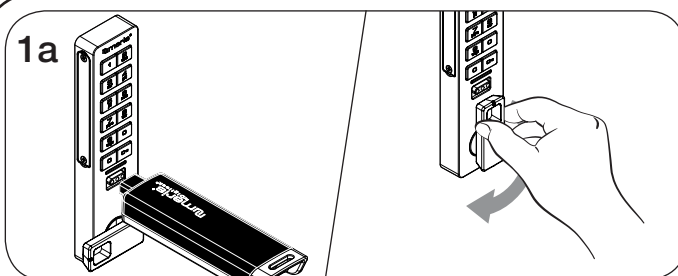

**Operate with a Manager Key**

To lock: Close the door. Insert a valid Manager Key then turn the knob to the locked position.

**1b**

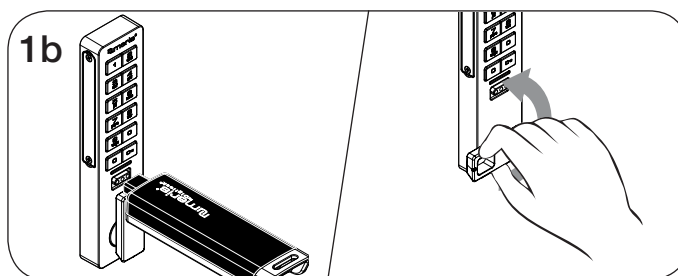

To unlock: Insert a valid Manager Key then turn the knob to the unlocked position.

Open the door.\*\*

\*After 3 consecutive incorrect User Code entries, the keypad will be disabled for 1 minute (Sleep Mode).

\*\*If a valid Manager Key is used to relock, the previous user credential will continue to operate the lock.



## Operating Instructions - In Assigned Use Functionality

In assigned use functionality, users operate the lock with their assigned user credential (either a User Code or a User Key).

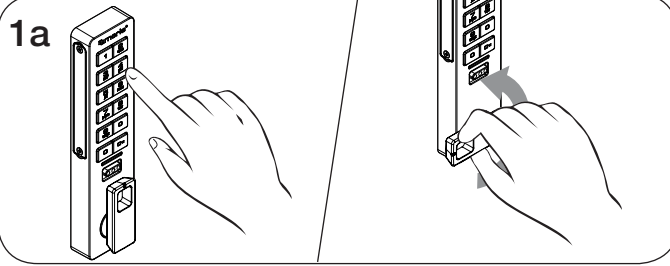

**1a**

**Operate with the User Code**

To unlock: Press **C** [the assigned 4-7 digit code] **OK** then turn the knob to the unlocked position. Open the door.\*†

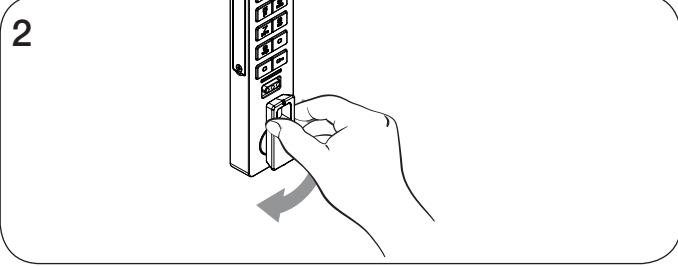

**2**

To lock: Close the door then turn the knob to the locked position.

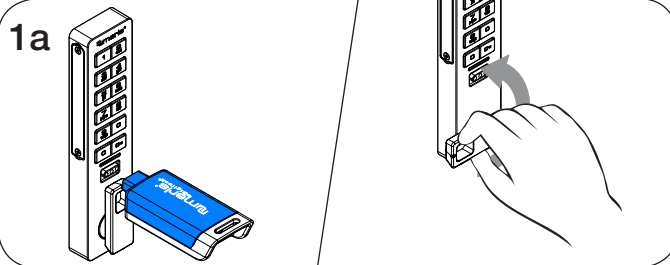

**1a**

**Operate with the User Key**

To unlock: Insert the assigned User Key then turn the knob to the unlocked position. Open the door.†

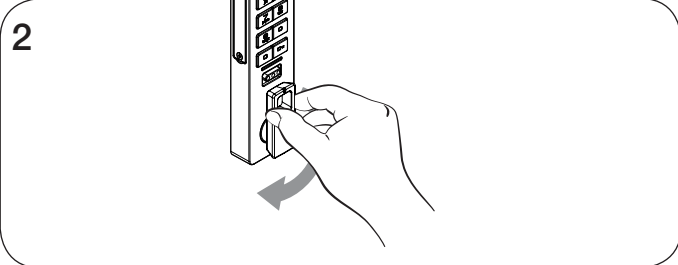

**2**

To lock: Close the door then turn the knob to the locked position.

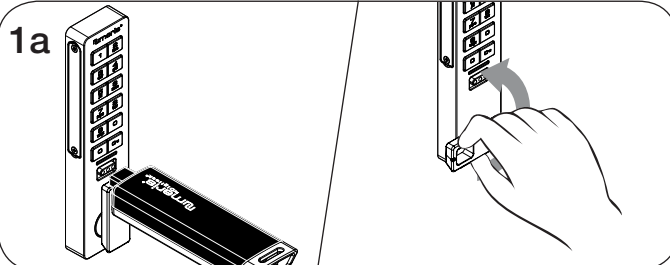

**1a**

**Operate with a Manager Key**

To unlock: Insert a valid Manager Key then turn the knob to the unlocked position. Open the door.†

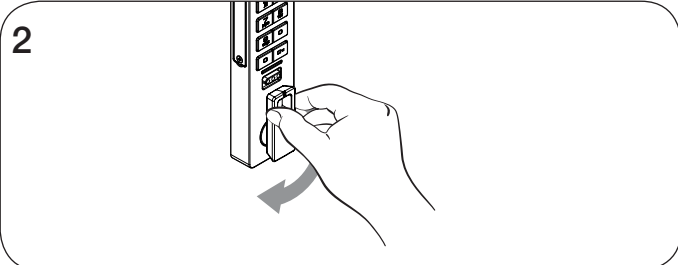

**2**

To lock: Close the door then turn the knob to the locked position.

\*After 3 consecutive incorrect User Code entries, the keypad will be disabled for 1 minute (Sleep Mode).

†The lock will remain in the locked position if the knob is not turned within approximately 6 seconds.

## Support

### Sleep Mode

After three consecutive incorrect User Code entries to unlock, the lock will enter Sleep Mode for one minute. For each subsequent incorrect entry, the lock will remain in Sleep Mode for an additional minute. The keypad is disabled while in Sleep Mode. A valid Manager Key may be used to unlock while lock is in Sleep Mode.

### Low Battery Indicator

After locking or unlocking, the lock emits two sets of three beeps indicating that the batteries are low. Replace the batteries.

### Does not Unlock with the User Code or User Key

The lock does not recognize the User Code or User Key. For immediate access, operate with a valid Manager Key. If in assigned use functionality, follow instructions to [Assign User Credentials](#) to assign a new User Code or User Key to the lock.

### Does not Operate with a Manager Key

The lock does not recognize the Manager Key. Follow instructions to [Add Manager Keys](#) to program the Manager Key to the lock. For immediate access, operate with another valid Manager Key.

### Does not Operate with the Programming Key

The lock does not recognize the Programming Key. If the Programming Key has been replaced, operate with the Replacement Programming Key. Contact Digilock support for additional assistance.

### No Audible Feedback when is Pressed

The lock may be in Sleep Mode or the batteries may need to be replaced. For immediate access, operate with a valid Manager Key. If the error condition persists, replace the batteries.

## Battery Replacement\*

It is not necessary to uninstall the lock from the door.

**CAUTION:** Risk of explosion or leakage if battery is replaced by an incorrect type, mixed with a different battery type, or inserted backwards. Replace all batteries of a set at the same time. Be sure to insert batteries with correct polarities. Remove exhausted batteries from product promptly and dispose of used batteries according to the battery manufacturer's instructions.

#### surface mount

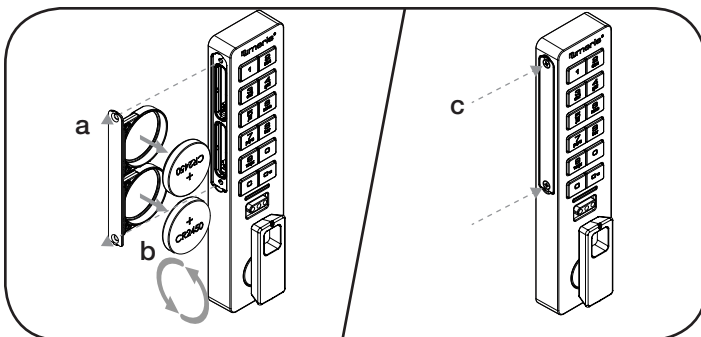

- a Remove the screws and the battery pack.
- b Replace the two premium lithium CR2450 batteries.
- c Re-Insert battery pack and screws.

#### recess mount

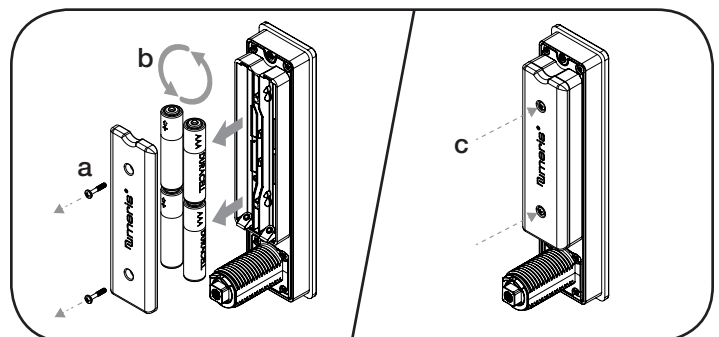

- a Remove the screws and the battery cover.
- b Replace the four premium AAA batteries.
- c Replace battery cover and screws.

\*In case of battery failure, operate with a valid Manager Key.