



iTEC[®]
one step forward

Wyłączny dystrybutor na Polskę

WANO
solutions

W celu uzyskania szczegółowych informacji
prosimy o kontakt: Tel.: +48 784 037 299

Fax: +48 61 624 85 38

www.wano.pl // biuro@wano.pl



LVN[®]

www.i-tec.com.pt

LVN®

Acesso através de tecnologia de proximidade!
Acceso a través de la tecnología de proximidad!
Access through proximity technology!

O LVN® funciona com RFID (Mifare) e está preparado para trabalhar com **NFC (Near Field Communication)**. Com este sistema pode controlar a sua rede de fechaduras com a mais recente tecnologia, tendo em conta a sua elevada capacidade de encriptação, garantindo toda a segurança. É compatível quer com o uso de cartão de proximidade, quer com porta-chaves ou telemóvel.

EL LVN® funciona con RFID (Mifare) y esta preparado para trabajar con la tecnología **NFC (Near Field Communication)**. Con este sistema pueden controlar las cerraduras de su red con la ultima tecnologia, teniendo en cuenta su gran capacidad de cifrado, garantizando asi la máxima seguridad. Es compatible tanto el uso de la tarjeta de proximidad, llavero o telefono.

The LVN® works with RFID (Mifare) card and is prepared to work with **NFC (Near Field Communication)**. With this system you can control the locks of your network with the latest technology, considering its high encryption capability, ensuring complete safety. It is compatible both with the use of proximity card or with key ring or mobile phone.

ESPECIFICAÇÕES/ ESPECIFICACIONES/ SPECIFICATIONS

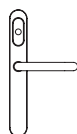

1. PS
PASSAGEM
PASAJE
PASSAGE

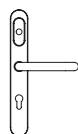

2. EA
COM CILINDRO
CON CILINDRO
WITH CYLINDER

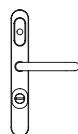

3. EP
PROTETOR DE CILINDRO
PROTECTOR DEL CILINDRO
CYLINDER PROTECTOR

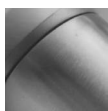

INOX SATINADO
INOXIDABLE SATÉN
STAINLESS SATIN

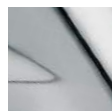

INOX POLIDO
INOX PULIDO
INOX POLISHED



INOX PVD



BRANCO
BLANCO
WHITE



PRETO
NEGRO
BLACK



OUTRAS CORES POR ENCOMENDA
OTROS COLORES POR PEDIDO
OTHER COLORS BY ORDER

Opções de puxadores / Opciones de manilla / Door handles options



A



B



C



D



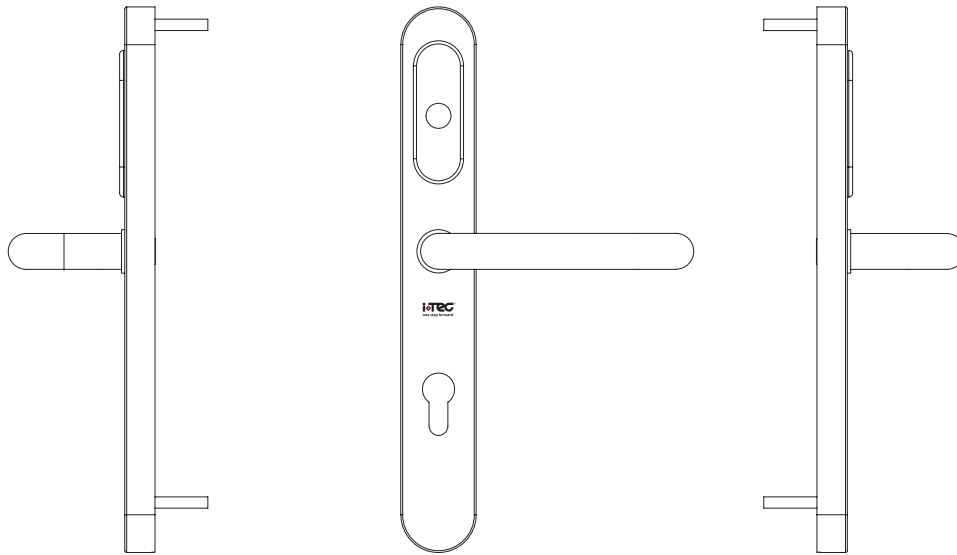

ESPECIFICAÇÕES COM/ ESPECIFICACIONES CON/ SPECIFICATIONS WITH SOFTWARE

 Aço Inoxidável Acero Inoxidable Stainless Steel	 Tempo aberto: 7s Tiempo abierto: 7s Open time: 7s	 Níveis de Utilizadores Niveles de Usuario User Levels
 Robusto Robusto Robust	 Abertura de emergência: Chave Mecânica Apertura de emergencia: Llave Mecánica Emergency opening: Mechanical key	 Sem Fios Sin Hilos Wireless
 Calendário Calendario Calendar	 Certificações: CE Certificaciones: CE Certifications: CE	 LED: Azul / Vermelho LED: Azul / Rojo LED: Blue / Red
 Acessos Futuros Accesos Futuros Futur Access	 Compatibilidade com diversos tipos de fechaduras / Compatibilidad con diferentes tipos de cerraduras / Compatibility with different locks types	 Consumo estático: 15µA Consumo estático: 15µA Static consumption: 15µA
 Master Card	 Cilindro de perfil europeu Cilindro de perfil europeo European profile cylinder	 Espessura da porta: 38-90mm Espesor de la puerta: 38-90mm Door thickness: 38-90mm
 Cartão Lista Negra Tarjeta Lista Negra Blacklist Card	 Modo Não Incomodar El modo No Molestar Do Not Disturb Mode	 Informação Bateria Baixa Información de Batería Baja Low Battery Warning
 Recolha de Dados Recolección de Datos Data Collection	 Peso: 1.28 Kg Peso: 1.28 Kg Weight: 1.28 Kg	 DC 4.5 (3 Pilhas AAA) DC 4.5 (3 Pilas AAA) DC 4.5 (3 AAA Batteries)
 Memória Memoria Memory	 Mifare 1k-4k, Compatível c/ NFC Mifare 1k-4k, Compatible c/ NFC Mifare 1k-4k, Compatible w/ NFC	 Consumo em funcionamento: 350mA Consumo en funcionamiento: 350mA Operating consumption: 350mA
 Gravação de Registos: 500 Grabación de Registros: 500 Recording Registries: 500	 Proteção IP55 Protección IP55 Protection IP55	 Temperatura de funcionamento: -30°C ~ +65°C Temperatura de funcionamiento: -30°C ~ +65°C Work temperature: -30°C ~ +65°C
 Backup Diário Backup Diario Daily Backup	 Humidade : <98% Humedad : <98% Humidity : <98%	
 Chave de Emergência Llave de Emergencia Emergency Key	 64.000 utilizadores 64.000 usuarios 64.000 users	

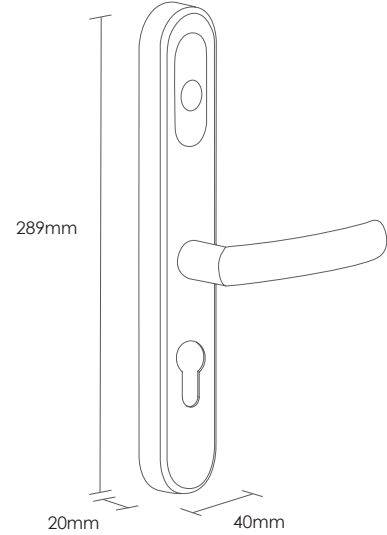
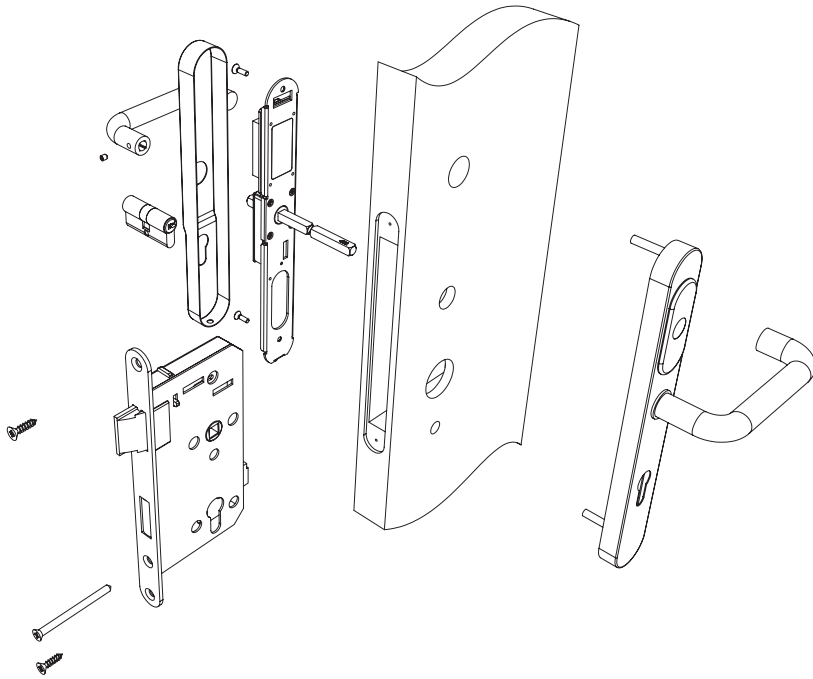

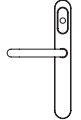
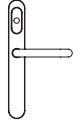
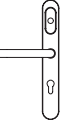
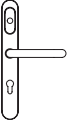
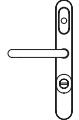
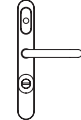
	esq. / izq. left	LVN PS	dir. / der. right	esq. / izq. left	LVN EA	dir. / der. right	esq. / izq. left	LVN EP	dir. / der. right
									
INOX SATINADO ACERO INOX STAINLESS STEEL	ITEC999000040082	ITEC999000040081	ITEC999000040027	ITEC999000040028	ITEC999000040084	ITEC999000040083			
INOX POLIDO ACERO INOX PULIDO STAINLESS STEEL POLISHED	ITEC999000040137	ITEC999000040136	ITEC999000040141	ITEC999000040140	ITEC999000040145	ITEC999000040144			
PVD	ITEC999000040139	ITEC999000040138	ITEC999000040143	ITEC999000040142	ITEC999000040147	ITEC999000040146			

LVN



You like it, keep it